



E-LINEKO-II

MANUAL



E-LINEKO-II





CONTENTS

Introduction.....	2
General.....	3-4
Handling & Storage.....	5-6
Points To Be Taken Into Consideration Before Installation.....	7-8
Joint Structure.....	9
Determination of Special Lengths & Offset Sizing.....	10
Busbar Mounting Instructions For Joints.....	11-12
Fire Barriers.....	13
Points To Be Taken Into Consideration After Installation.....	14-15
KOP 40/80 Tap Off Boxes.....	16
KOP 160-250-400 Tap Off Boxes.....	17
Feed Box Installation (B10, B11).....	18
Energizing / Before Energizing.....	19
Energizing The Equipment.....	20
Maintenance.....	21



These instructions should be read carefully and acted upon before taking delivery of equipment on site.

Dear Customer,

EAE Elektrik A.Ş. Products are designed to provide the maximum benefit in efficiency and service. Our products are manufactured in accordance with IEC standards and EAE is quality assured to ISO9001 standards in their modern factories in Istanbul .

The components that you have purchased are manufactured in a completely environment conscious, that is ISO 14001 certified.

These instructions should be read carefully and acted upon before taking delivery of equipment on site.

Handling, installation and operation of busbar systems should be carried out only by skilled, trained and authorized personnel using all associated equipment such as rubber gloves, helmet, safety glasses or face shields and flash resistant clothing in accordance with established safety practices.

Please do not handle the equipment in any other way than the instructions in this manual to be indicate.

1- Installation according to the project of the busbar system, planning and coordination with other distribution systems (mechanical, heat, steam, air installation etc.) is crucial.

2- Operational Success of the Busbar systems is ensured by adhering to the right transport, proper installation and design. Improper application may cause malfunction of the system, personal injury and damage to operating systems.

3- The installation, operation and maintenance of the busbar system should only be carried out by qualified personnel who know the dangers associated with installation a, construction and operation of electrical equipment for the purposes of this manual. Additionally, this personnel ;

- * Knows the requirement of applicable electrical laws, other laws and standards.

- * Be trained and authorized to test, energize, clean, ground, label and lock the system and equipment suitable for occupational safety applications.

- * Be trained in the use and maintenance of personal protective equipment such as rubber gloves, helmets, protective goggles or face shields and gauze-resistant clothing in accordance with relevant work safety practices and potential hazard levels.

- * Must be trained in first aid.

WARNING:

Dangerous voltage levels in the electrical components may result in the hazardous injury and death.

Installation, monitoring and maintenance must be carried out on de-energized busbar electrical equipment. In this way, unintentional contact to the equipment under the energy is prevented. must be followed all warnings and related instructions.

WARNING :

Operation of the busbar damaged by water or moisture can caused damage property, serious personal injury or death. To ensure proper installation resistance and to ensure that the moisture source is removed, observe the notes in section on page 16 item 13 you receive.

BUSBARS SHOULD NOT BE IN TOUCH WITH ANY LIQUID MATERIAL

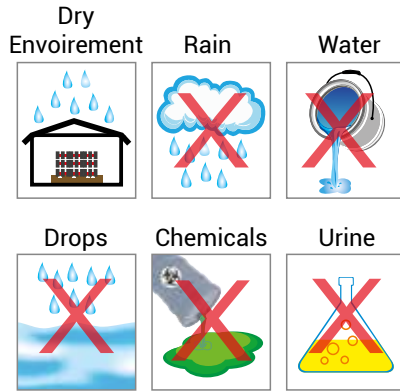

**CLOSE
INDIRECT or DIRECT
WATERWAYS**

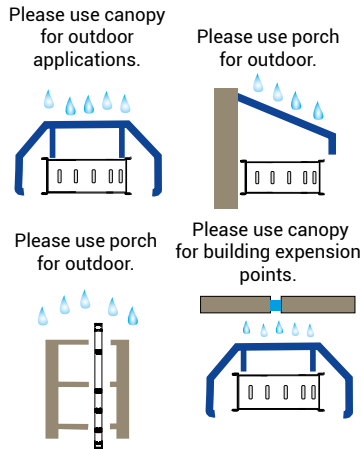

BUSBARS THAT ARE NOT ASSEMBLED COMPLETELY HAVE NO PROTECTION AGAINST TO WATER

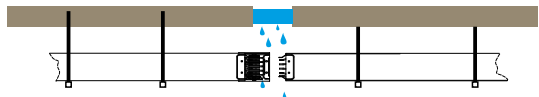

KO-II MANUAL

► Handling & Storage



1- General guidelines are given to protect the busbar straight lengths and modules and reduce the risk of personal injury and equipment damage during handling on site.

2- As soon as the container or truck arrives on site, a suitable forklift is required for easy and convenient unloading from vehicle directly to the ground level.

3- All pallets should be checked by unpacking them sufficiently to inspect them for possible transit damage and to determine that the shipment is complete and correct as per Packing List provided.

* If any of the items is missing from the Packing List or any piece is damaged during transportation, Insurance Company must be informed immediately for proper reporting with all required documents for further action.

4- All busbar straight lengths and modules should be handled with care to avoid damage to internal components and the twisting of housing or its finish.

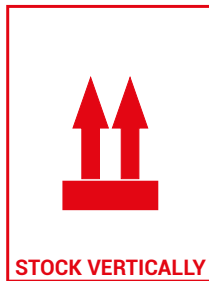

5- When the lengths and modules are required to be taken from the pallets to the erection area, those should be hoisted using metal rods or bars passed through the 2 sets of holes at each end of the housing body by ensuring the load is stable and safely secured. Then adequate sling and slinging method can be used for shifting from one place to another.

6- The removal of the products from one floor to the other floor must be done by means of a suitable electric and mechanical crane or elevator.

7- Repack the Busbar if you need to store or hold before installation (Refer to chapter5.) as long as conditions permit, do not disassemble the busbar until it reaches the lastest installation point.

8- Storage area should be a clean, dry space with a uniform temperature to prevent condensation and having adequate air circulation and protected from dirt, fumes, water. Storage area should be free of vehicle traffic to prevent physical damage to the products.

9- When busbar straight lengths and modules are to be stored for certain time before installation, restore the packing for protection during that period and cover them with waterproof sheet in very well protected area from dust and any kind of liquid on sufficient quantities of wooden bearers.

10- The busbar designed for the outdoor environment are not weatherproof until the insallation is complete and in accordance with the instructions and above recommended storage conditions must be applied for other busbars.

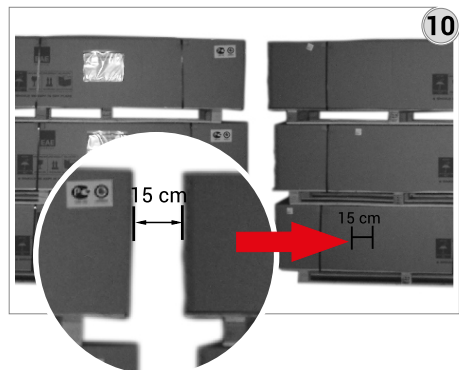

►► Installation

►Points to be taken into consideration before installation

IMPORTANT!

1- Please read this instruction manual before commencing the busbar installation. Incorrect or incomplete mounting may cause damage to the equipment or system.

2- Installation of the busbar system should commence after reading through busbar application drawings. Locate the positions of individual pieces such as transformer-panel connections, expansion units, feeder units, end feeder units etc. and check that they are in accordance with the project drawings.

3- **⚠ Seismic support systems should be used in earthquake risk areas. Please contact our company for details of seismic support products and project planning.**

The recommended distance between supports is 1.5m, the maximum distance is 2m. Make sure that support positions do not block either joint covers or tap off points.

4- DDT modules should be used at min. 20cm distance to the each floor concrete.

5- If the busbar lines are used in the transition of building dilatations, appropriate dilatation module should be chosen. Please contact our company for support.

6- Busbar system should be handled with care either by forklift, crane or any other means which will not damage the product while transporting or lifting. When transporting busbar, position its weight evenly. Generally vertical installation is provided in vertical lines. Please read additional installation instructions.

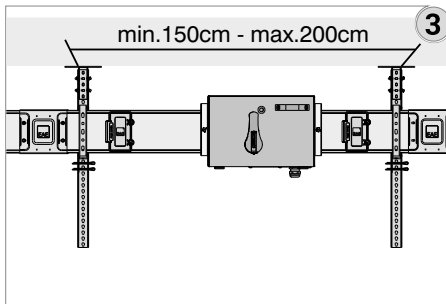

►► Installation

►Points to be taken into consideration before installation

7- When install horizontal and vertical , it must be aligned correctly to prevent collapses and bends.

8- Protect the busbar against water and moisture from unfinished roofs and walls during installation.

9- Tools required for the installation,

Micrometer type adjustable/calibrated torque spanner

½ inch square drive size 10mm, 13mm and

19mm socket

Drilling Machine

Size 10mm Spanner/Socket

Screwdriver

Hoist with cloth sling

10- The busbar to be installed needs to be hung min 4 points, as shown in below picture.

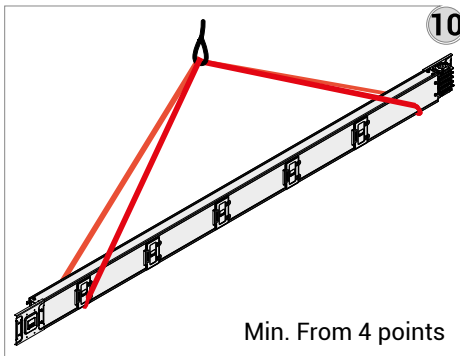

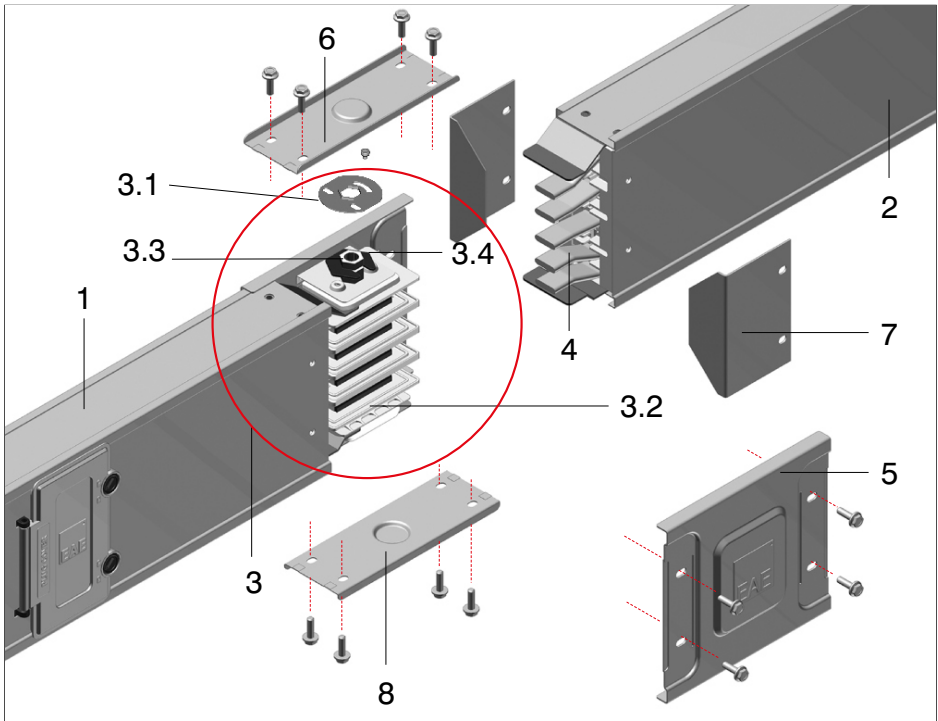

Figure 1

KX busbars are manufactured in 3m lengths as standard, with special lengths as detailed on the project drawings. All modules have a block joint end and the other end of the module has not block joint.

(See as shown Figure 1)

- 1- 1st Busbar
- 2- 2nd Busbar
- 3- Block Joint
 - 3.1-Locker Piece
 - 3.2-Insulators
 - 3.3-Double Headed Nut
 - 3.4-Plastic Separator Piece
- 4-Conductors
- 5-Front Cover Plate
- 6-Top Cover Plate
- 7-Joint Protection Plate
- 8-Bottom Cover Plate

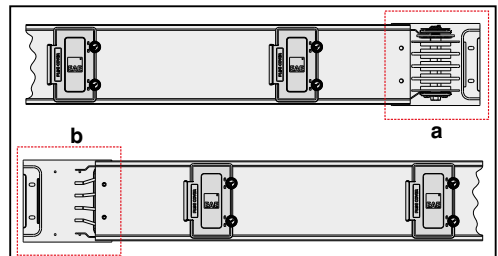

Figure 2

1- Special length (particular or custom size) busbars are used in places where standard sizes do not fit when the busbar is mounted and in other similar places. The minimum length for these special element is 35cm. Please measure the lengths of these modules as shown below.

2- Length A is measured between housing of 2 busbars in cm. "A". The special length is calculated by deducting 25cm from this measured length.

$X = A - 25$ (cm) X=Length of Special Busbar
(The busbar module will be manufactured as per X value.)

3- In the case in where custom-made intermediate-size busbars are required, both ends of the intermediate-size busbars can be produced with or without block joints. In such cases, please contact our company for technical support and technical information.

Note: Please send a drawing for combined offsets when ordering. Indicate bolted and non-bolted ends on the drawing.

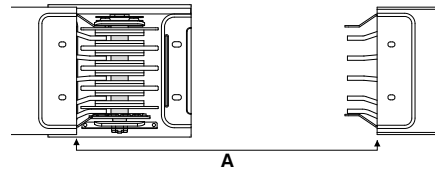

Vertical Offset min = 200 mm

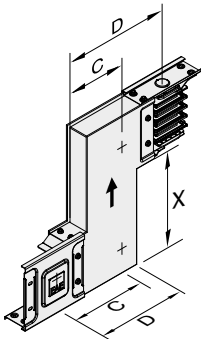

Horizontal Offset X=min:150mm

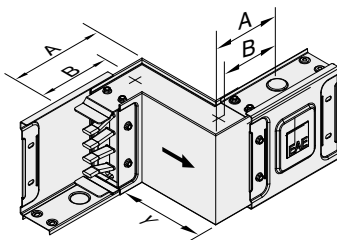

	Current	A	B	C	D
Aluminium	160	180	145	200	290
	250	185	147	200	290
	315	190	150	200	290
	400	210	160	200	290
	500	222	166	200	290
	600	235	172	200	290
	800	270	190	200	290
Copper	250	180	145	200	290
	315	185	147	200	290
	400	190	150	200	290
	600	210	160	200	290
	800	235	172	200	290

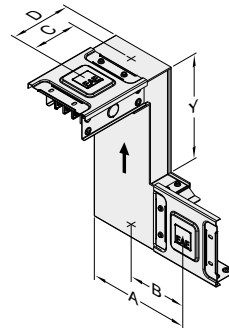

Combined Offset min = 200 mm

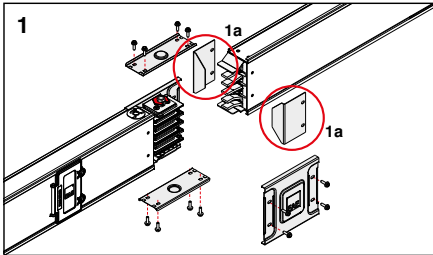

1- Remove joint top cover plate, joint side cover plate and the screws from non-block joint bolt. (Pieces marked as 1a should be thrown away.)

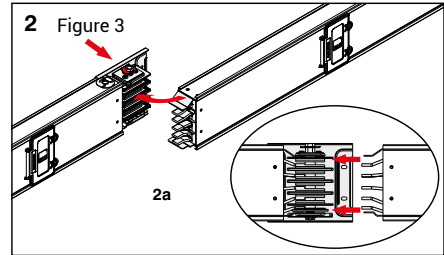

2- Introduce bolted and non-bolted ends of the busbar into each other carefully, until the cover plate screws can be put in.

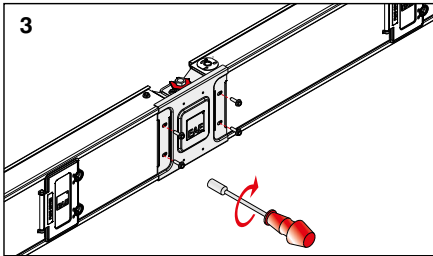

3- Fix the joint side cover of the block joint.

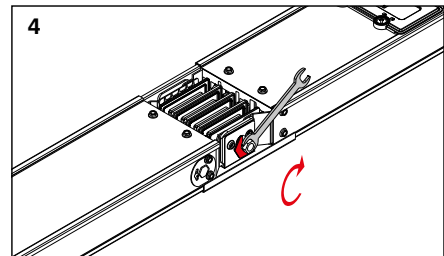

4- Tighten the double headed nut until upper nut is broken.

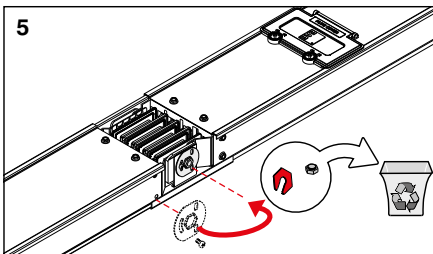

5- Take away the broken nut and plastic separator.

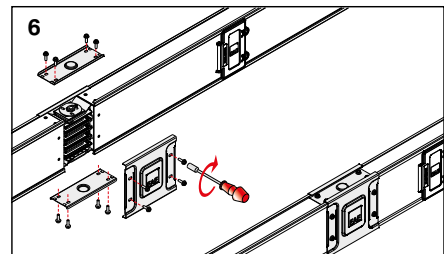

6- Install top and bottom joint cover plates. Check the joint before fitting the last joint side cover plate. Fit the joint cover side plate and tighten the screws. Check the position of the earth conductor when installing KO-II with five conductors.

►► Installation

► Busbar Mounting Instructions For Joints

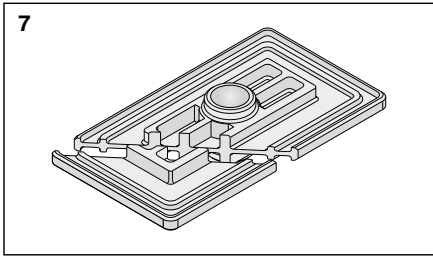

7- Ensure that the insulation plates of the joint, are not cracked or broken.

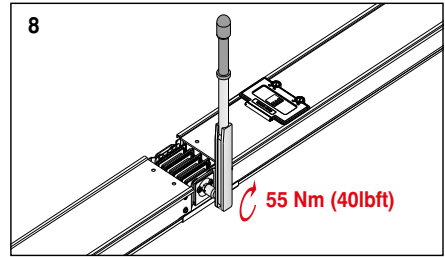

8- If removal is required for any reason, tighten the nut using a calibrated torque wrench adjusted to 55 Nm (40 lbft) after re-fitting the block joint set.

►► Installation of End Closer

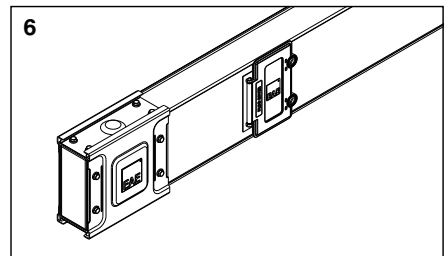
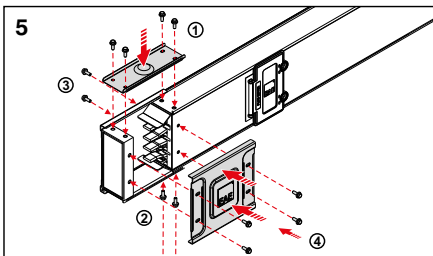
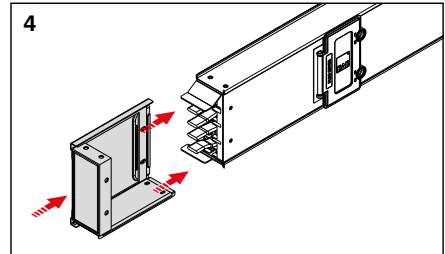
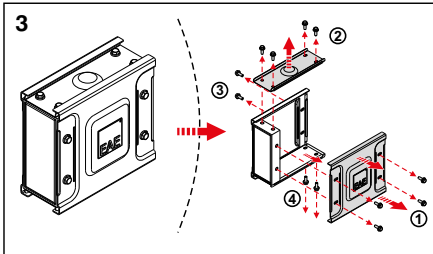
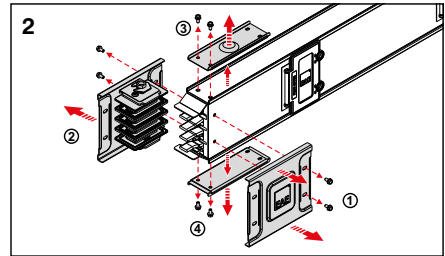
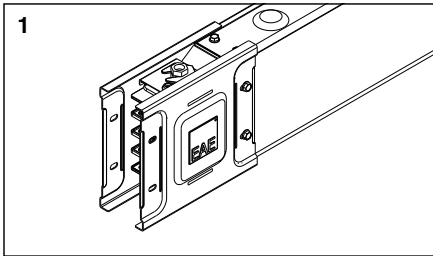

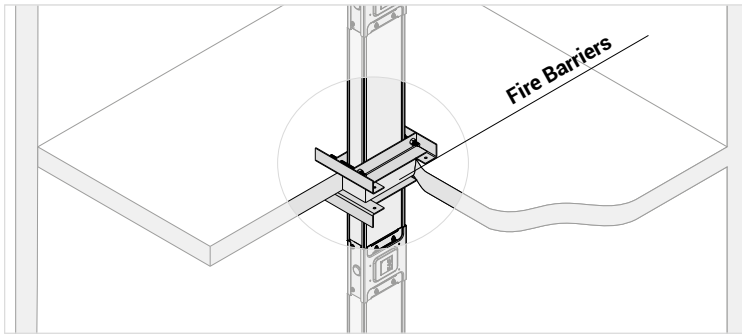

Sample Order: 250 A, Copper, IP 55, 5 Conductors Fire Barrier
KOC 0255- II -STD-150-40

Fire Barriers

Fire barriers are used to prevent the transition of flame and smoke from one zone to another in case of fire. The fire barriers prevent the chimney effect of air insulated busbar.

Dimensioning of Fire Barrier

When placing an order for fire barriers to be installed in the KO-II busbar, the following information is required :

1. Thickness of floor or wall in cm. (A mm)
2. Centreline dimension of the fire barrier should be measured from the side without the block joint. (Y mm)
3. There will be no plug-in points at the fire barrier location.
4. EAE Supplies a 300 mm thick fire barrier as standard when wall or floor thickness is not stated.
5. The minimum length for these special elements with fire barrier is 600 mm.

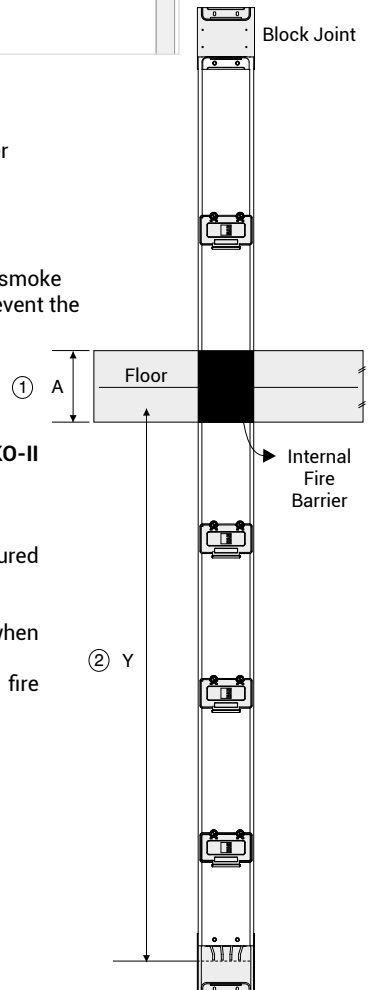

►► Installation

►Points To Be Taken Into Consideration After Installation

1- When the installation has been completed, please check the position of the neutral conductor along the busbar run. (Taking special care at locations where the run makes turns and offsets)

2- Carry out insulation test (minimum 1000V AC). Make sure that no protective device (switch, disconnect, etc.) is connected to the system and that the earth - neutral line is separate. All tap of boxes on the line must be set to «0». Keep in mind that the results can vary according to the busbar length, width or number of bars. The results may also vary according to the moisture content. Values should not be less than 1 MegaOhm / 30 meters. It is recommended that no energy is supplied to the line even if the insulation test is completed successfully.

2.2 ELECTRICAL CHECKS (ELEKTRİKSEL KONTROLLEME)				
MEGGER TEST (MEGGER TESTİ)				
Rated Insulation Voltage (Buhatır İzolasyon Gerilimi (V)):				
Megger Test Voltage (Ekipmanlar Meger Test Gerilimi):				
*Test Voltage must be 1000V for busbars rated insulation voltage up to 1000V, test voltage must be 600V for rated insulation voltage up to 600V.				
*Yüksek izolasyon gerilimli 1000V'a kadar olan busbarlar için test voltajı 1000V, 600V'a kadar olan busbarlar için test voltajı 600V'dir.				
*Ölçülen dirençler en az 1MΩ/30m standarttır.				
*Ölçümün sonucu değeri en az 1MΩ/30m standarttır.				
L1-L2	Ohm > 1.0 MΩ	<input type="checkbox"/>	L1-N	Ohm >
L1-L3	Ohm > 1.0 MΩ	<input type="checkbox"/>	L1-PE	Ohm >
L2-L3	Ohm > 1.0 MΩ	<input type="checkbox"/>	L2-PE	Ohm >
L1-N	Ohm > 1.0 MΩ	<input type="checkbox"/>	L3-PE	Ohm >
L2-N	Ohm > 1.0 MΩ	<input type="checkbox"/>	N-PE	Ohm >

2.1- When the busbar system is energized for the first time, qualified electrical personnel must be present. If short circuits and earth faults are detected due to any damage or faulty installation practices, serious damage can occur if the power is turned on.

2.2- When the power is supplied, there must be no electrical load in the busbar.

2.3- After the busbar system is energized, loads must be switched in sequence (main and sub feed).

2.4- When the busbar is used properly, it will have a moderate hum. Excessive noise may be an indication of hardware that has not been extruded or incorrectly mounted metal parts.

2.5- Spark formation at any point along the busbar is not normal. The busbar must be de-energized and de-energized until the spark condition is corrected.

3- Do not try to install five conductor units to four conductor units or vice versa.

4- Do not apply any kind of oil or chemical at the joints or to the contacts of tap off boxes.

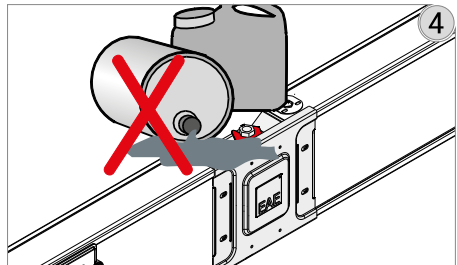

►► Installation

►Points To Be Taken Into Consideration After Installation

5- Do not use any other means than original tap off boxes to supply energy from the busbar.

6- Current rating of the busbar run should be equal to the rating of the breaker. Do not exceed busbar nominal current during operation.

7- Make sure that any additional loads to the system following do not exceed the nominal current capacity of the busbar.

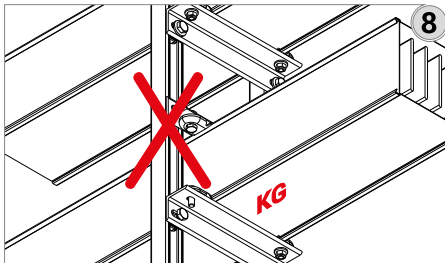
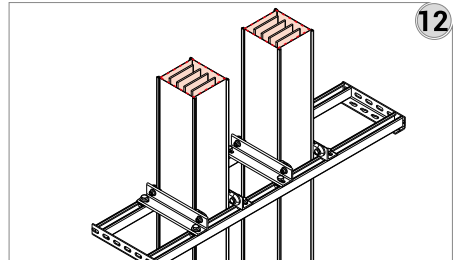

8- Do not use busbar system as a supporting structure for other systems.

9- Do not use busbar system as a walk way.

10- Do not light a fire or use welding equipment near the busbar.

11- Take care when handling the system components. Do not drop the units.

12- Do not cut or drill the busbar units. Please consider below picture when installing the busbar for vertical applications. Please do not drill the busbar at any place where is marked with red on the picture.

13- Take precautions against adverse environmental conditions such as rain and snow. In addition, the busbar dripping cement, etc. inside the building. Protect from water, malfunctioning piping and all fluids that may come from water jets. Cover if necessary. Cap the ends to the busbar joint points that have not been installed at the end of the work.

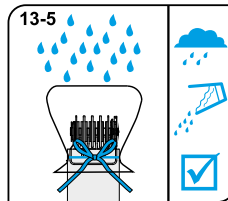
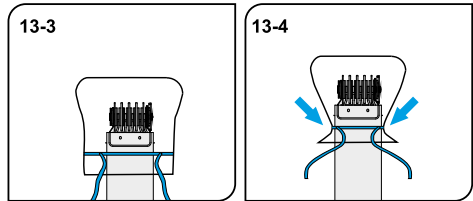
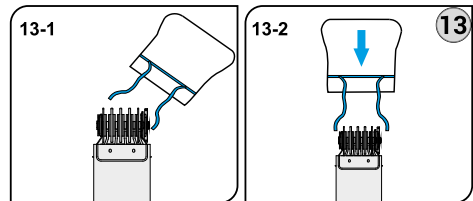

14- Ensure the selected degree of protection (IP rating) of the system is suitable for the working environment.

15- You can remove paint defects on product's surface which could happen during transporting and installation operation by retouching with spray paint. (Also you can have information about the paint color that you have ordered from the manufacturer) We recommend you to clean up surfaces with a dry cloth in advance where painting process will be.

Important!

When the cover is closed, due to interlock security mechanisms, tap off box can not be installed or removed from the busbar.

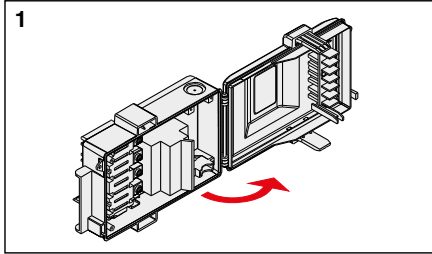

1- Open the cover of the plastic tap off box.

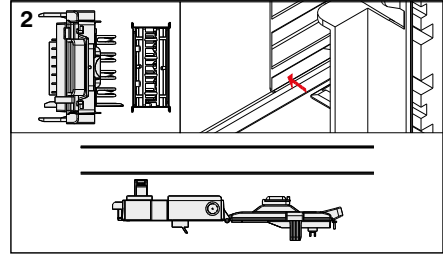

2- Hold the box in parallel to the busbar, check the position of the earth contact.

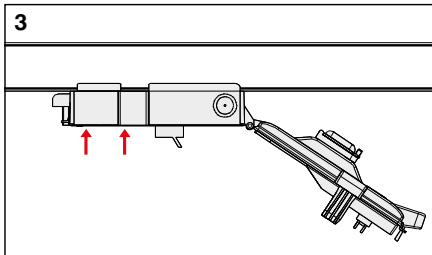

3- Carefully align the tap off box contacts and push the box towards the busbar.

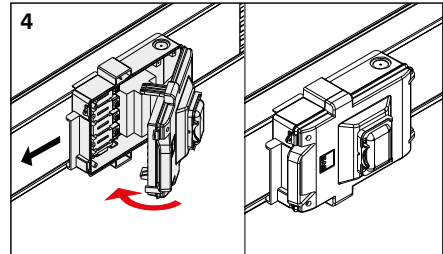

4- When the box is secured to the busbar housing, closed the box cover and tighten the screws.

Attention!

Check the box once more before making connections.

Important!

When the cover is closed, due to interlock security mechanisms, tap off box can not be installed or removed from the busbar.

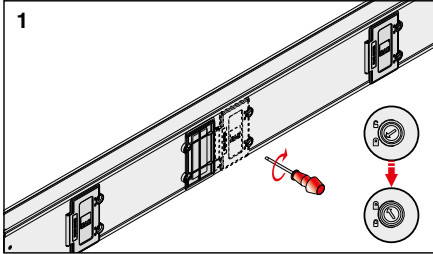

1- Open Plug-in cover by using screw driver.

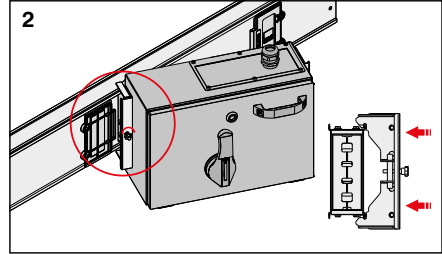

2- Release the plastic headed bolt to loosen mechanical fixing clamps. Push left side of tap-off box towards busbar and lock fixing clamps to the busbar. Tight back the plastic headed bolt to hold busbar rigidly.

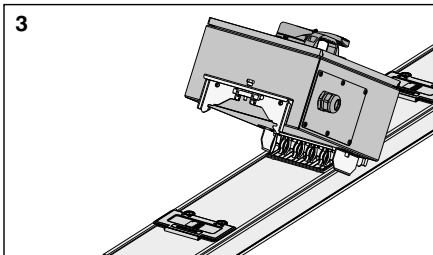

3- Carefully align the tap-off box contacts and push right side of tap-off box towards busbar and be sure fixing tap-off box firmly.

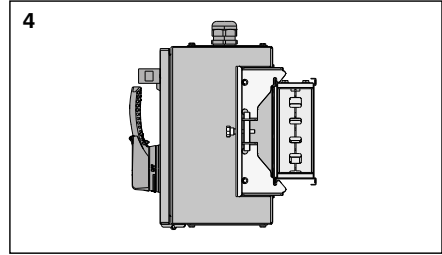

4- Tight the plastic headed bolt on the right side to fix the tap-off box mechanically to the busbar.

►► Energizing

► Feed Box Installation (B10, B11)

1- When installing the feeder boxes B10, B11 make sure that the phase sequence of the feed box matches the phase sequence of the busbar. (Care is to be exercised ensuring the neutral is correctly connected)

2- For multiway busbars check the position of the paralleling conductor link, make sure that they are available and fitted correctly. Do not remove these conductor links.

3- Cable glands should be selected according to the size and number of feeder cables. Please consult to factory for requirements other the standard supplied ones.

4- Make sure that the incoming feeder cables to the box are all the same length for each phase.

5- Do not cut or drill the feeder units.

►► Energizing

►► Before Energizing

WARNING: HIGH VOLTAGE VALUES CAN CAUSE DEATH OR SERIOUS INJURIES. MAINTENANCE, INSTALLATION AND OBSERVATIONS IN THE CONSEQUENTIAL CONDITIONS; THE ENERGY AND THE CONNECTION MAY BE DONE ON THE BUSBARS CUT OFF AND ELECTRICAL ISOLATED. THEREFORE, ACCIDENTAL RESPONSE TO BE CONTACTED BY PARTS UNDER ELECTRICALLY. FOLLOW ALL MANUFACTURER'S WARNINGS AND INSTRUCTIONS

1- Make sure that all joint zone connections are correct. Follow the manufacturer's recommended torque.

2- Make sure that all bolt-on and plug-in boxes are in the "off" position. Boxes without power interrupts must be removed from the busbar if they cannot be isolated with auxiliary power breakers.

3- Make sure that the connections between the busbar and the panel, transformer and other connections are interrupted.

4- Resistance testing is to be carried out with a resistance tester of 1000 volts per part of the busbar to ensure that the system does not contain short circuit and ground faults. (Phase-earth, phase-neutral, phase-to-phase). Record the results of the test and deliver it to the project or the responsible company. Note that the results may vary depending on the busbar length, width, or number of bars. The results may also vary according to the humidity. If the values are less than 1 MegaOhm / 30 meters, please contact the manufacturer.

5.1- Before connecting the busbar to the transformer, panel and other connections, make sure that the phase of the system and the phase of the busbar overlap.

5.2- Make sure that the ventilation and drainage holes are open. Make sure that the screws and plugs in the drain holes for the outdoor busbars are removed according to the manufacturer's instructions.

► Energizing

► Before Energizing

6.1- It is recommended that no energy is applied to the line even if the insulation resistance test described in section 7.4 is successfully completed.

6.2- When the equipment is energized for the first time, qualified electrical personnel must be present. If short circuits and earth faults due to damage or poor installation practices are not detected in the exit procedure, serious damage may occur when the power is turned on.

6.3- When the power is supplied, the busbar must not have an electrical load. Since the busbar typically runs through several rooms and ground level, care must be taken to see that all devices supplied by the busbar path are in the "OFF" position.

6.4- The equipment must be energized in sequence starting from the welding end of the system and working towards the load side. In other words, it energizes the main devices, then the feeder devices and then the branch-circuit devices. Turn the devices to the "ON" position with a solid positive motion.

6.5- Once all overcurrent devices have been switched on, loads such as lighting circuits, contactors, heaters and motors can be turned ON.

6.6- When properly used, the busbar will have a moderate hum. Excessive noise may be an indication of hardware that has not been extruded or incorrectly mounted metal parts.

6.7- All busbar ratings, routings and supporting systems should be checked as per final isometric drawings.

7- All busbar ratings, routings and supporting systems should be checked as per final isometric drawings.

8- All busbar system should be checked visually to be certain that they are clean and secure. Loose and/or contaminated connections increase electrical resistance which can cause overheating.

9- Any type of blower or compressed air should not be used to avoid blowing dust into busbar joints, tap off boxes or circuit breakers. If there is accumulation of dust and dirt, clean it off by using a soft brush, vacuum cleaner, or clean lint free rags.

10- All joints should be correctly tightened according to the torque value given and should be marked. Then install the locking plates correctly.

11- All Tap Off boxes fed from the busbar should be on "OFF" position.

12- The busbar runs should be isolated by disconnecting all connections to transformers, switchboards, meters, etc.

13- Insulation resistance test with an insulation resistance test equipment rated 1000V AC should be conducted to verify the integrity of the system. This test should be performed between phases, neutral and earth. Permanent records should be kept of resistance readings. If the insulation reading appears to be lower than 1 megaohm, then the cause should be investigated.

14- The system phase sequence should be checked in order to match the busbar phases sequence before reconnecting all connections to transformers, switchboards, meters, etc.

Energizing The Equipment

1- The equipment should be only energized by authorised personnel.

2- There should be no electrical load on the busbar system when it is energized.

3- Hazardous voltages in electrical equipment can cause severe personal injury or death. Energizing a busbar run for the first time is potentially dangerous. Therefore system operational voltage should be checked

4-The connected equipment should be energized in sequence by starting at the source to end of the system

5- After all overcurrent devices have been turned on, loads such as lighting circuits, contactors, heaters and motors may be turned "ON".

6-EAE busbar system is particularly quiet when operating normally. In some installations however there may be a moderate hum. Excessive noise may be an indication of hardware that has not been tightened or of metal parts that have been improperly assembled and this should be checked after de-energizing the system and isolating it safety.

►► Maintenance

► Busbar Runs

Important!

Hazardous voltages in electrical equipment can cause severe personal injury or death unless otherwise specified. Installation, inspection and preventive maintenance should only be performed on busbar system to which power been turned off, disconnected and electrically isolated so that no accidental contact can be made with energized parts.

Operation of busbar trunking which has been water or moisture damaged can cause property damage, severe personal injury, or death. Observe the precautions to assure adequate insulation resistance and that sources of moisture are eliminated. Latest IEC 61439-6 and locally applicable safety related work practices should be followed at all times.

Tap Off Boxes With Protective Devices

1- EAE tap off boxes are not equipped with any protective device unless they are required by customer. Any type of devices can be fixed in tap off boxes providing specific informations about device prior to manufacture in order to adjust interlock mechanism.

2- Tap off boxes operating mechanisms of all electrical & mechanical interlocks should be exersized to determine that they operate freely to their full on and off positions.

Important!

Hydrocarbon spray propellants and, hydrocarbon based sprays or compounds will cause degradation of certain plastics. Contact EAE before using these products to clean, dary, or lubricate components during installation or maintenance.

1- An external inspection of the system should be carried out once a year.

2- Any dripping or other source of moisture onto the busbar modules should be eliminated from installed area.

3- The total continuous load current should be measured by proper instrument that does not exceed the current rating on the busbar name plate or the designated design current.

4- After performing all of the above inspections and necessary repairs, it may be desirable to perform an infra-red temperature test on all electrical connections after busbar system is re-energized and reaches a stabilized operating temperature.



A series of horizontal dashed lines spanning the width of the page, providing a template for writing or drawing.

PRODUCT TYPES



BUSBAR ENERGY DISTRIBUTION SYSTEMS



CABLE TRAYS



TROLLEY BUSBAR ENERGY DISTRIBUTION SYSTEMS



INDOOR SOLUTIONS



SUPPORT SYSTEMS

Please visit our website for the updated version of our catalogues.
www.eaelectric.com



EAE Elektrik A.S.
Head Office
Akcaburgaz Mahallesi,
3114. Sokak, No:10 34522
Esenyurt - Istanbul - TURKEY
Tel: +90 (212) 866 20 00
Fax: +90 (212) 886 24 20

EAE DL 3 Factory
Busbar
Makine ihtisas Organize Sanayi
Bolgesi Mahallesi, 6. Cadde,
8. Sokak, No:6 41455
Dilovası - Kocaeli - TURKEY
Tel: +90 (262) 502 05 65
Fax: +90 (262) 502 05 70



KO-II Manual / En. / Rev 02 1.000 pcs 18/11/2021

S.S

EAE has full right to make any revisions or changes on this catalogue
without any prior notice.